



Electromotoric Actuators

SFP21/18**SFP71/18**

for small valves VVP47.., VXP47.., VMP47..

- **SFP21/18 AC 230 V operating voltage, 2-position control signal**
- **SFP71/18 AC 24 V operating voltage, 2-position control signal**
- **135 N positioning force**
- **Spring return**
- **Manual adjustment**
- **For direct mounting with union nut (no tools required)**
- **Integral 1.8 m connecting cable**
- Auxiliary switch, type ASC2.1/18 (optional)

Use

The SFP21/18 and SFP71/18 actuators are used in conjunction with zone valves VVP47.., VXP47.. and VMP47.., primarily in heating, ventilation, air conditioning and refrigeration systems for water-based control of low-temperature hot water and cooling water. The SFP.. actuators together with the 3-port valves VXP47.. are suitable for low leakage change over applications.

Functions

The electric actuator requires an on/off controller (thermostat) to control the valve. If the temperature of the medium deviates from the set-point, the controller output signal causes the actuator to drive the valve open. When the temperature of the medium reaches the set-point, the control signal is cut off and the valve closes again.

Type summary

| Prod. no. | Operating voltage | Positioning time | Control signal | Connecting cable |
|-----------|-------------------|------------------|----------------|------------------|
| SFP21/18 | AC 230 V | 10 s | 2-position | 1.8 m |
| SFP71/18 | AC 24 V | | | |

Accessories

| Prod. no. | Description | Switching point | Switching capacity | Connecting cable |
|-----------|------------------------------|-----------------------|--------------------|------------------|
| ASC2.1/18 | Auxiliary switch open/closed | At approx. 50% stroke | AC 250 V / 3(2) A | 1.8 m |

Ordering

Example:

| Product number | Stock number | Designation | Quantity |
|----------------|--------------|--------------------------|----------|
| SFP71/18 | SFP71/18 | Electromotoric Actuators | 2 |
| ASC2.1/18 | ASC2.1/18 | Auxiliary Switch | 1 |

Delivery

Actuators, valves and accessories are supplied separately. The actuator is supplied with the AL50 ring.

Rev. no.

See overview

Equipment combinations

| Type code | Valve type | k_{vs} [m ³ /h] | PN class | Data sheet |
|-----------|-----------------------------|---------------------------------|----------|------------|
| VVP47.. | 2-port valves | 0.25...4.0 | PN16 | 4847 |
| VXP47.. | 3-port valves | 0.25...4.0 | | |
| VMP47.. | 3-port valves with T-bypass | 0.25...2.5 | | |

Technical design / Mechanical design

The valve is opened electrically by the actuator and closed by spring force. It incorporates a synchronous motor, a gear mechanism and a return spring. The electric motor is overload-resistant and anti-locking, so that continuous operation is possible. The maximum stroke is limited mechanically. The closing motion, by contrast, includes an overrun for the gear mechanism. This protects the gear mechanism from mechanical shock and increases service life. The valve is connected by an 1.8 m cable, which is an integral part of the actuator.

Accessories

ASC2.1/18 auxiliary switch

The optional auxiliary switch can be fitted to the actuator with two screws.

It switches at a stroke of approx. 50 %.

- Valve actuator de-energized:
→ Auxiliary switch open
- Voltage applied to valve actuator:
→ Auxiliary switch closed (50 ... 100 % stroke)
- Manual adjuster locked into position (approx. 90 % stroke):
→ Auxiliary switch closed

See "Technical data" for further information on the auxiliary switch, page 5.

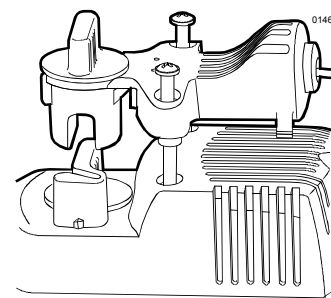

Notes

Engineering

The admissible temperatures (see "Technical data", page 5) must be observed.

Electrical connection

- The actuator may be operated only with alternating current (AC 230 V for SFP21/18 and AC 24V for SFP71/18)

⚠ Caution

- **Phase cut and pulse-width-modulated signals are not suitable.**
- Recommended number of opening/closing operations: approx. 50 per day, with 200 heating or cooling days

Mounting

Mounting instructions are enclosed with the packaging. Mount ring AL50 prior to mounting the actuator onto V..P47.. valves.

Orientation

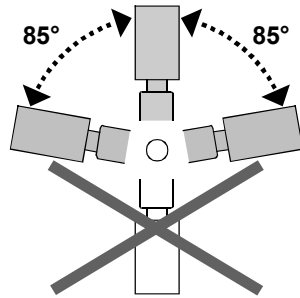

Commissioning

- Check the wiring.
- Check the functioning of the actuator and of the auxiliary switch, if fitted.

Operating

The valve can be opened manually by use of a lever on the actuator. When the valve is approximately 90% open this locks into position. When electrical operation is resumed, the locking mechanism is released automatically.

Manual adjustment

Opening the valve manually

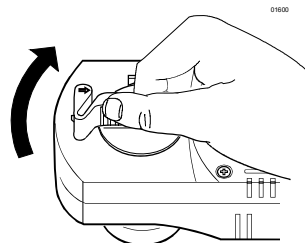

Locking the lever into position at a valve opening of approx. 90%

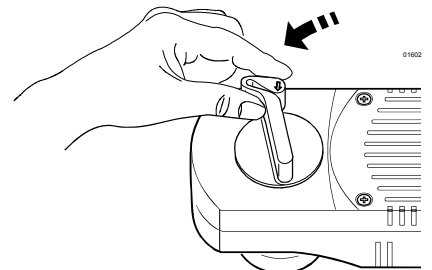

Releasing the lever manually

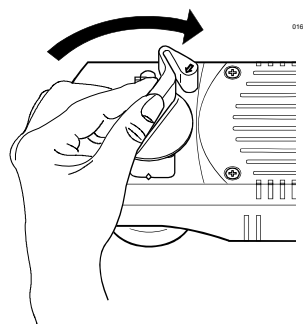

Rotate lever as far as the mechanical stop, and release.

Maintenance

- The actuators require no maintenance.
- In the event of a fault, the actuator can be replaced without removing the valve. The operating voltage must be switched off during this process.
- The actuators cannot be repaired.

Disposal

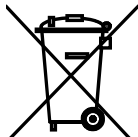

The device contains electrical and electronic components and must not be disposed of together with domestic waste. This applies in particular to the PCB.

Legislation may demand special handling of certain components, or it may be sensible from an ecological point of view.

Current local legislation must be observed.

Warranty

The technical data given for these applications is valid only when the valves are used with the actuators described under "Equipment combinations", page 2.

The use of type SFP.. actuators with third-party valves invalidates any warranty offered by Siemens Building Technologies / HVAC Products.

Technical data

| | | SFP21/18 | SFP71/18 | |
|---|---|---|--|--|
| Power supply | Operating voltage | AC 230 V | AC 24 V | |
| | Voltage tolerance | ± 15% | ± 20% | |
| | Frequency | 50 Hz | | |
| | Max. power consumption | 9.8 VA | | |
| | Fuse protection for incoming cable | Max. 3 A (external) | | |
| Control | Control signal | On/off via temperature controller <i>Phase cut and pulse-width-modulated signals are not suitable.</i> | | |
| | Opening/closing operations | Recommended number: approx. 10 000 / year (equivalent to approx. 50 per day) | | |
| Operating data | Position with de-energized actuator 2-port valve (VVP47..) 3-port valve (VXP47.. and VMP47..) | A → AB closed A → AB closed, B → AB open | | |
| | Positioning time | Opened by motor: 10 s Closed by spring: 30...50 s | | |
| | Nominal stroke | 2.5 mm | | |
| | Positioning force | 135 N | | |
| | Manual adjustment | 0...90 % | | |
| | Admissible temperature of medium in the connected valve: | 1...110 °C | | |
| | Electrical connection | Connecting cable (integral) | 2-core, 1.8 mm 18 AWG (0.96 mm ²) | |
| | Norms and Standards | CE-conformity to EMC directive | 2004/108/EC | |
| Immunity | | EN 61000-6-2 | Industrial ³⁾ | |
| Emissions | | EN 61000-6-3 | Residential | |
| Low Voltage Directive | | 2006/95/EC | | |
| Electrical safety | | EN 60730-1 | | |
| Protection class to EN 60730, Section 2.7 | | Class II | Class III | |
| Pollution degree | | to EN 60730, 2 | | |
| Housing protection Upright to horizontal | | IP30 to EN 60529 | | |
| Environmental compatibility | ISO 14001 (Environment) | | | |
| | ISO 9001 (Quality) SN 36350 (Environmentally compatible products) RL 2002/95/EG (RoHS) | | | |
| Dimensions / Weight | Dimensions | See "Dimensions", page 6 | | |
| | Weight | | | |
| | without auxiliary switch with auxiliary switch | 0.585 kg 0.692 kg | 0.585 kg 0.692 kg | |
| Materials | Base-plate Housing | Die-cast aluminum Polycarbonate | | |
| Housing colors | Base and cover | Light gray, RAL7035 | | |
| Auxiliary switch (optional) | Switch type | Changeover contact | | |
| | Switching point | at approx. 50 % stroke | | |
| | Switching capacity | AC 250 V 3 A resistive 2 A inductive | | |
| | Connecting cable | 3-core, 1.8 mm 18 AWG (0.96 mm ²) | | |

General ambient conditions

| | Operation EN 60721-3-3 | Transport EN 60721-3-2 | Storage EN 60721-3-2 |
|--------------------------|---------------------------|---------------------------|-------------------------|
| Environmental conditions | Class 3K3 | Class 2K3 | Class 2K3 |
| Temperature | +1 ... +50 °C | -25 ... +70 °C | -5 ... +50 °C |
| Humidity | 5 ... 85 %rh | < 95 %rh | 5 ... 95 %rh |

Connecting cable

| Cable | SFP21/18 AC 230 V | | SFP71/18 AC 24 V | |
|---|----------------------|-------------|---------------------|-------------|
| | Cable color | Connection | Cable color | Connection |
| Operating voltage 2-core | Brown | L | Red | G |
| | Blue | N | Black | G0 |
| Auxil. switch ASC2.1/18 (optional) 3-core | Black / Red | Input | Black / Red | Input |
| | Black / Blue | N/C contact | Black / Blue | N/C contact |
| | Black / Pink | N/O contact | Black / Pink | N/O contact |

Dimensions

All dimensions in mm

Actuators without auxiliary switch SFP21/18, SFP71/18

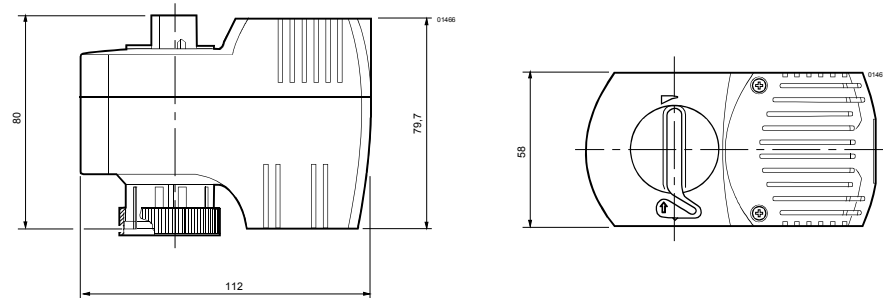

Actuators with auxiliary switches SFP21/18, SFP71/18 with ASC2.1/18

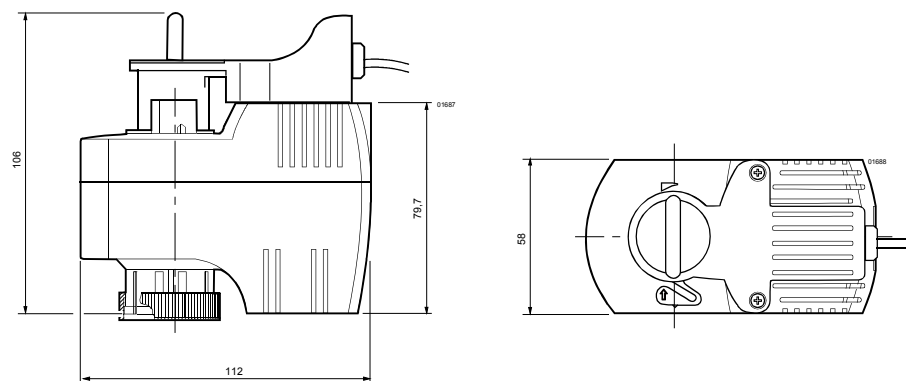

Revision numbers

| Product number | Valid from rev. no. | Product number | Valid from rev. no. |
|----------------|---------------------|----------------|---------------------|
| SFP21/18 | H | SFP71/18 | H |