



Electrohydraulic actuators for valves

with a 40 mm stroke

SKC32..
SKC82..
SKC62..
SKC60

- **SKC32..** Operating voltage AC 230 V, 3-position control signal
- **SKC82..** Operating voltage AC 24 V, 3-position control signal
- **SKC6..** Operating voltage AC 24 V, control signal DC 0...10 V, 4...20 mA or 0...1000 Ω
- **SKC6..** Choice of flow characteristic, position feedback, stroke calibration, LED status indication, override control
- **SKC62UA** with functions choice of direction of operation, stroke limit control, sequence control with adjustable start point and operating range, operation of frost protection monitors QAF21.. and QAF61..
- **Positioning force 2800 N**
- **Actuator versions with or without spring-return function**
- **For direct mounting on valves; no adjustments required**
- **Manual adjuster and position indicator**
- **Optional functions with auxiliary switches, potentiometer and stem heater**
- **SKC..U are UL-approved**

Use

For the operation of Siemens 2-port and 3-port valves, types VVF.. and VXF.. with a 40 mm stroke as control and safety shut-off valves in heating, ventilation and air conditioning systems.

Types

| | Type | Operating voltage | Positioning signal | Spring-return | | Positioning time | | Enhanced functions |
|----------------------|-------------------------------|-------------------|--|---------------|------|------------------|---------|--------------------|
| | | | | Function | Time | Opening | Closing | |
| Standard electronics | SKC32.60 | AC 230 V | 3-position | | | 120 s | 120 s | |
| | SKC32.61 ²⁾ | | | yes | 18 s | | | |
| | SKC82.60 | | | | | | | |
| | SKC82.60U * | | | | | | | |
| | SKC82.61 | yes | | 18 s | | | | |
| | SKC82.61U * | | | | | | | |
| Enhanced electronics | SKC62 ²⁾ | AC 24 V | DC 0...10 V, 4...20 mA, or 0...1000 Ω | yes | 20 s | 20 s | | yes ¹⁾ |
| | SKC62U * | | | | | | | |
| | SKC60 | | | | | | | |
| | SKC62UA * | | | yes | 20 s | | | |

¹⁾ Direction of operation, stroke limit control, sequence control, signal addition

²⁾ Control devices MK..5.., MK..6.. and MK..5..G are TÜV tested per DIN EN 14597 and can therefore be used as control devices with safety shut-off function for protection against excessive temperature and pressure.

* UL-approved versions

TÜV tested as per DIN EN 14597

| Product No. | Stock number | Description | Data sheet |
|-------------|--------------|--|------------|
| MK..5.. | S55329-M1.. | Control device PN 25 for safety function per DIN EN 14597, for water | N4387 |
| MK..6. | S55329-M1.. | Control device PN 40 for safety function per DIN EN 14597, for water, steam, brine and heat transfer oil | N4388 |
| MK..5..G | S55329-M1.. | Control device PN 25 for safety function per DIN EN 14597, for steam | N4389 |

Accessories

| Type | Description | For actuator | Mounting location |
|----------------|-------------------------|--------------------|-------------------|
| ASC1.6 | Auxiliary switch | SKC6.. | 1 x ASC 1.6 |
| ASC9.3 | Dual auxiliary switches | SKC32.. SKC82.. | 1 x ASC9.3 or |
| ASZ7.3 | Potentiometer 1000 Ω | | 1 x ASZ7.3 or |
| ASZ7.31 | Potentiometer 135 Ω | | 1 x ASZ7.31 or |
| ASZ7.32 | Potentiometer 200 Ω | | 1 x ASZ7.32 |
| ASZ6.5 | Stem heater AC 24 V | SKC.. | 1 x ASZ6.5 |

Ordering

When ordering please specify the quantity, product name and type code.

Example: 1 actuator, type SKC32.60 and

1 potentiometer, 135 Ω, type ASZ7.31

Delivery

The actuator, valve and accessories are supplied in separate packaging and not assembled prior to delivery.

Spare parts

See overview, section «Replacement parts», page 17.

Equipment combinations

| Valve type | | DN | PN-class | k_{vs} [m ³ /h] | data sheet |
|---|---------|-----------|------------------|------------------------------|------------|
| Two-port valves VV... (control valves or safety shut-off valves): | | | | | |
| VVF21... | Flange | 100 | 6 | 124...160 | 4310 |
| VVF31... | Flange | 100...150 | 10 | 124...315 | 4320 |
| VVF40... | Flange | 100...150 | 16 | 124...315 | 4330 |
| VVF41... | Flange | 65...150 | 16 | 49...300 | 4340 |
| VVF45... | Flange | 65...150 | 16 | 49...300 | 4345 |
| VVF43.. | Flansch | 65...150 | 16 ¹⁾ | 50...400 | 4404 |
| VVF53.. | Flansch | 65...150 | 25 | 63...400 | 4405 |
| VVF61... | Flange | 65...150 | 40 | 49...300 | 4382 |
| Three-port valves VX... (control valves for «mixing» and «diverting»): | | | | | |
| VXF21... | Flange | 100 | 6 | 124...160 | 4410 |
| VXF31... | Flange | 100...150 | 10 | 124...315 | 4420 |
| VXF40... | Flange | 100...150 | 16 | 124...315 | 4430 |
| VXF41... | Flange | 65...150 | 16 | 49...300 | 4440 |
| VXF43.. | Flansch | 65...150 | 16 ¹⁾ | 63...400 | 4404 |
| VXF53.. | Flansch | 65...150 | 25 | 63...400 | 4405 |
| VXF61... | Flange | 65...150 | 40 | 49...300 | 4482 |

¹⁾ For DN ≤ 50 see VVF53.. or VXF53.. PN 25 (Data sheet N4405): Flange dimensions PN 25 same as for PN 16

For admissible differential pressures Δp_{max} and closing pressures Δp_s , refer to the relevant valve data sheets.

Note Third-party valves with strokes between 12...40 mm can be motorized, provided they are «closed with the de-energized» fail-safe mechanism and provided that the necessary mechanical coupling is available. For SKC32.. and SKC82.. actuators the Y1 signal must be routed via an additional freely-adjustable end switch (ASC9.3) to limit the stroke.

We recommend that you contact your local Siemens office for the necessary information.

Rev. no.

Overview table, see page 17.

Technology

Principle of electro-hydraulic actuators

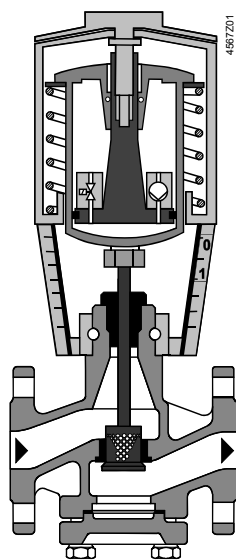

Valve closed

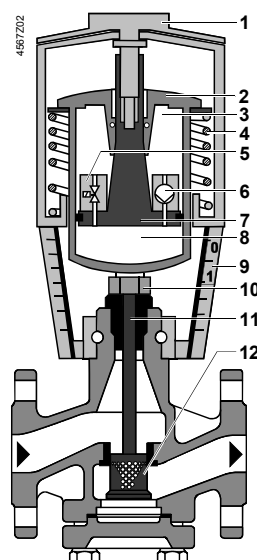

Valve open

- 1 Manual adjuster
- 2 Pressure cylinder
- 3 Suction chamber
- 4 Return spring
- 5 Solenoid valve
- 6 Hydraulic pump
- 7 Piston
- 8 Pressure chamber
- 9 Position indicator (0 to 1)
- 10 Coupling
- 11 Valve stem
- 12 Plug



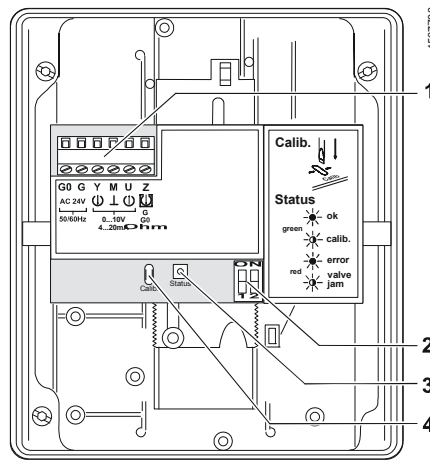

| | |
|---|---|
| Opening the valve | The hydraulic pump (6) forces oil from the suction chamber (3) to the pressure chamber (8) and thereby moving the pressure cylinder (2) downwards. The valve stem (11) retracts and the valve opens. Simultaneously the return spring (4) is compressed. |
| Closing the valve | Activating the solenoid valve (5) allows the oil in the pressure chamber to flow back into the suction chamber. The compressed return spring moves the pressure cylinder upwards. The valve stem extends and the valve closes |
| Manual operation mode | Turning the manual adjuster (1) clockwise moves the pressure cylinder downwards and opens the valve. Simultaneously the return spring is compressed. In the manual operation mode the control signals Y and Z can further open the valve but cannot move to the «0%» stroke position of the valve. To retain the manually set position, switch off the power supply or disconnect the control signals Y and Z. The red indicator marked «MAN» is visible. |
| Note: Controller in manual operation | When setting the controller for a longer time period to manual operation, we recommend adjusting the actuator with the manual adjuster to the desired position. This guarantees that the actuator remains in this position for that time period. Attention: Do not forget to switch back to automatic operation after the controller is set back to automatic control. |
| Automatic mode | Turn the manual adjuster counterclockwise to the end stop. The pressure cylinder moves upward to the «0%» stroke position of the valve. The red indicator marked «MAN» is no longer visible. |
| Minimal volumetric flow | The actuator can manually be adjusted to a stroke position > 0 % allowing its use in applications requiring constantly a minimal volumetric flow. |
| Spring-return facility | The SKC32.61, SKC82.61.. and SKC62.. actuators, which feature a spring-return function, incorporate an additional solenoid valve which opens if the control signal or power fails. The return spring causes the actuator to move to the «0 %» stroke position and closes the valve. |
| TÜV tested as per DIN EN 14597 | Control devices TÜV tested per DIN EN 14597 can be used as control devices with safety shut-off function for protection against excessive temperature and pressure: <ul style="list-style-type: none"> ▪ Water: MK..5.., PN 25, see data sheet N4387 ▪ Steam: MK..5..G, PN 25, see data sheet N4389 ▪ Water, steam, brine, heat transfer oil: MK..6.., PN 40, see data sheet N4388 |
| SKC32../SKC82.. 3-position control signal | The valve is controlled by a 3-position signal either via terminals Y1 or Y2 and generates the desired stroke by means of above described principle of operation. <ul style="list-style-type: none"> • Voltage on Y1 piston extends valve opens • Voltage on Y2 piston retracts valve closes • No voltage on Y1 and Y2 piston / valve stem remain in the respective position |
| SKC62.., SKC60 Y control signal DC 0...10 V and/or DC 4...20 mA, 0...1000 Ω | The valve is either controlled via terminal Y or override control Z. The positioning signal Y generates the desired stroke by means of above described principle of operation. <ul style="list-style-type: none"> • Signal Y increasing: piston extends valve opens • Signal Y decreasing: piston retracts valve closes • Signal Y constant: piston / valve stem remain in the respective position • Override control Z see description of override control input, page 8 |
| Frost protection monitor Frost protection thermostat | A frost protection thermostat can be connected to the SKC6.. actuator. The added signals from the QAF21.. and QAF61.. require the use of SKC62UA actuators. Notes on special programming of the electronics are described under «Enhanced electronics» on page 5. «Connection diagrams» for operation with frost protection thermostat or frost protection monitor refer to page 15. |

Standard electronics
SKC62..., SKC60



- 1 Connection terminals
- 2 Mode DIL switches
- 3 LED status indication
- 4 Slot for calibration

DIL switches
SKC62..., SKC60

| | Positioning signal Y Position feedback U | Flow characteristic |
|---------------|--|--|
| ON |  DC 4...20 mA |  lin = linear |
| OFF *) |  DC 0...10 V |  log = equal percentage |

*) Factory setting:
All switches OFF

Relationship
between control
signal Y and
volumetric flow

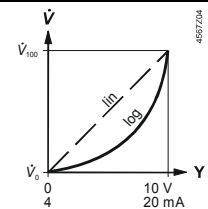



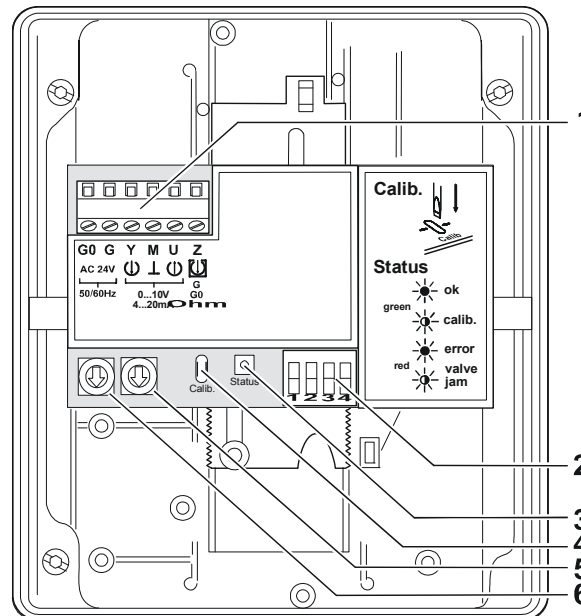





Enhanced electronics
SKC62UA



- 1 Connection terminals
- 2 DIL switches
- 3 LED status indication
- 4 Stroke calibration
- 5 Rotary switch **Up**
(factory setting 0)
- 6 Rotary switch **Lo**

DIL switches
SKC62UA

| | Direction of operation | Sequence control or stroke limit control | Control signal Y Position feedback U | Flow characteristic |
|--------------|--|--|--|--|
| ON |  reverse-acting |  Sequence control Signal addition QAF21../QAF61.. |  DC 4...20 mA |  lin = linear |
| OFF * |  direct-acting |  Stroke limit control |  DC 0...10 V |  log = equal percentage |

* Factory settings: all switches OFF

Relationship between control signal Y and volumetric flow

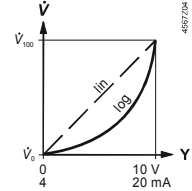

Selection of direction of operation
SKC62UA

- With normally-closed valves, «direct-acting» means that with a signal input of 0 V, the valve closes (applies to all Siemens valves listed under «equipment combinations» on page 3)
- With normally-open valves, «direct-acting» means that with a signal input of 0 V, the valve is open.

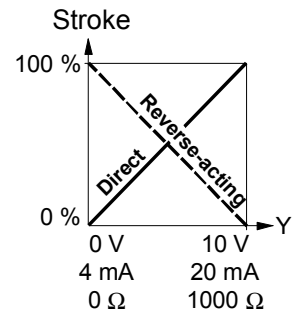
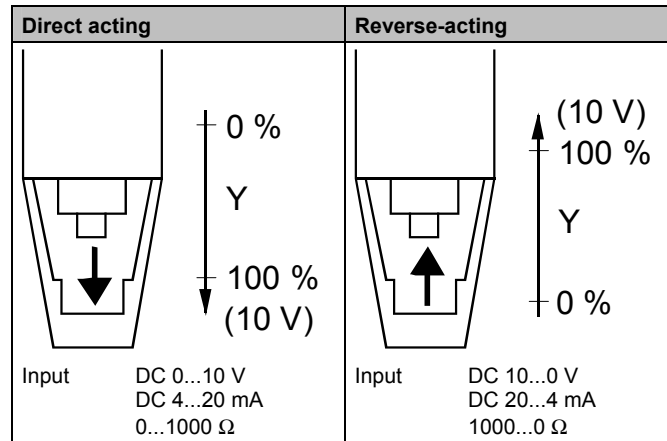

Note The mechanical spring-return function is not affected by the direction of operation selected.

Stroke limit control and sequence control
SKC62UA

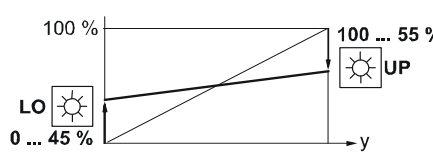
| Setting the stroke limit control | | | |
|---|--------------------|----------------|--------------------|
| The rotary switches LO and UP can be used to apply an upper and lower limit to the stroke in increments of 3%, up to a maximum of 45% | | | |
|  | | | |
| Position of LO | Lower stroke limit | Position of UP | Upper stroke limit |
| 0 | 0 % | 0 | 100 % |
| 1 | 3 % | 1 | 97 % |
| 2 | 6 % | 2 | 94 % |
| 3 | 9 % | 3 | 91 % |
| 4 | 12 % | 4 | 88 % |
| 5 | 15 % | 5 | 85 % |
| 6 | 18 % | 6 | 82 % |
| 7 | 21 % | 7 | 79 % |
| 8 | 24 % | 8 | 76 % |
| 9 | 27 % | 9 | 73 % |
| A | 30 % | A | 70 % |
| B | 33 % | B | 67 % |
| C | 36 % | C | 64 % |

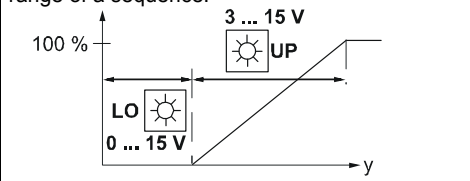
| Setting the sequence control | | | |
|---|-------------------------------------|----------------|-------------------------------------|
| The rotary switches LO and UP can be used to determine the starting point or the operating range of a sequence. | | | |
|  | | | |
| Position of LO | Starting point for sequence control | Position of UP | Operating range of sequence control |
| 0 | 0 V | 0 | 10 V |
| 1 | 1 V | 1 | 10 V * |
| 2 | 2 V | 2 | 10 V ** |
| 3 | 3 V | 3 | 3 V *** |
| 4 | 4 V | 4 | 4 V |
| 5 | 5 V | 5 | 5 V |
| 6 | 6 V | 6 | 6 V |
| 7 | 7 V | 7 | 7 V |
| 8 | 8 V | 8 | 8 V |
| 9 | 9 V | 9 | 9 V |
| A | 10 V | A | 10 V |
| B | 11 V | B | 11 V |
| C | 12 V | C | 12 V |

| | | | |
|---|------|---|------|
| D | 39 % | D | 61 % |
| E | 42 % | E | 58 % |
| F | 45 % | F | 55 % |

| | | | |
|---|------|---|------|
| D | 13 V | D | 13 V |
| E | 14 V | E | 14 V |
| F | 15 V | F | 15 V |

- * Operating range of QAF21.. (see below)
- ** Operating range of QAF61.. (see below)
- *** The smallest adjustment is 3 V; control with 0...30 V is only possible via Y.

Stroke control with
QAF21.. / QAF61..
signal addition
SKC62UA only

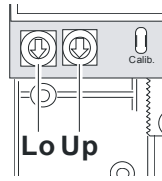

| Setting the signal addition | | | |
|---|------------------------------|----------------|-----------------------------------|
| The operating range of the frost protection monitor (QAF21.. or QAF61..) can be defined with rotary switches LO and UP. | | | |
| Position of LO | Sequence control start point | Position of UP | QAF21.. / QAF61.. operating range |
| 0 | | 1 | QAF21.. |
| 0 | | 2 | QAF61.. |

Calibration
SKC62.., SKC60

In order to determine the stroke positions 0 % and 100 % in the valve, calibration is required on initial commissioning:

Prerequisites

- Mechanical coupling of the actuator SKC6.. with a Siemens valve
- **⚠ Actuator must be in «Automatic operation» enabling stroke calibration to capture the effective 0 % and 100 % values**
- AC 24 V power supply
- Housing cover removed

Calibration

1. Short-circuit contacts in calibration slot (e.g. with a screwdriver)
2. Actuator moves to «0 %» stroke position (1) (valve closed)
3. Actuator moves to «100 %» stroke position (2) (valve open)
4. Measured values are stored

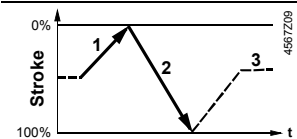
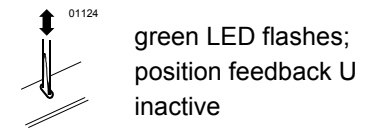

Normal operation

5. Actuator moves to the position (3) as indicated by signals Y or Z
green LED is lit permanently; position feedback U active, the values correspond to the actual positions

A lit red LED indicates a calibration error.

The calibration can be repeated any number of times.

The LED status indication indicates operational status with dual-colored LED and is visible with removed cover.

Indication of operating state
SKC62.., SKC60

| LED | Indication | Function | Remarks, troubleshooting |
|-------|------------|---------------------------------------|---|
| Green | Lit | Normal operation | Automatic operation; everything o.k. |
| | Flashing | Calibration in progress | Wait until calibration is finished (LED stops flashing, green or red LED will be lit) |
| Red | Lit | Faulty stroke calibration | Check mounting Restart stroke calibration (by short-circuiting calibration slot) |
| | Flashing | Internal error | Replace electronics |
| Both | Dark | Inner valve jammed | Check valve |
| | | No power supply Electronics faulty | Check mains network, check wiring Replace electronics |

As a general rule, the LED can assume only the states shown above (continuously red or green, flashing red or green, or off).

Override control input Z
SKC62..., SKC60

Override control input can be operated in following different modes of operation

| | | Z-mode | | | | |
|--------------------|-----------------|---|--|---|---|---|
| | | no function | fully open | closed | override with 0...1000 Ω | Signal addition SKC62UA only |
| Connections | | | | | | 4567210 |
| | Transfer | | | | | |
| | | linear or equal-percentage | | | linear or equal-percentage | linear or equal-percentage |
| | | <ul style="list-style-type: none"> Z-contact not connected Valve stroke follows Y-input | <ul style="list-style-type: none"> Z-contact connected directly to G Y-input has no effect | <ul style="list-style-type: none"> Z-contact connected directly to G0 Y-input has no effect | <ul style="list-style-type: none"> Z-contact connected to M via resistor R Starting position at 50 Ω / end position at 900 Ω Y-input has no effect | <ul style="list-style-type: none"> Z-contact is connected to R of the frost protection monitor QAF21.. or QAF61.. Valve stroke follows signals Y and R(Z) |

Note Shown operation modes are based on the factory setting «direct acting»
Y-input has no effect in Z-mode.

Accessories

SKC..

ASZ6.5
stem heater

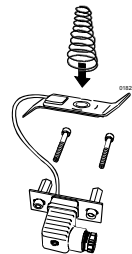

- for media below 0 °C
- mount between valve and actuator

SKC32..., SKC82..

ASC9.3
double auxiliary switch

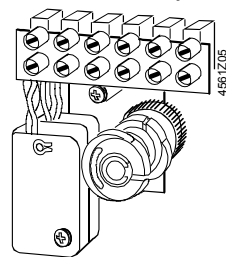

adjustable switching points

ASZ7.3..
potentiometer

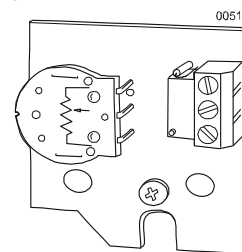

- ASZ7.3: 0...1000 Ω
- ASZ7.31: 0...135 Ω
- ASZ7.32: 0...200 Ω

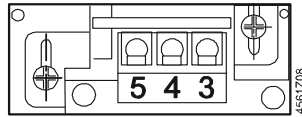

switching point 0...5 % stroke

See section «Technical data» on page 12 for more information.

Engineering notes

Conduct the electrical connections in accordance with local regulations on electrical installations as well as the internal or connection diagrams.

Caution

Safety regulations and restrictions designed to ensure the safety of people and property must be observed at all times!

Caution

For media below 0 °C the ASZ6.5 stem heater is required to keep the valve from freezing. For safety reasons the stem heater is designed for an operating voltage of AC 24 V / 30 W.

For this case, do not insulate the actuator bracket and the valve stem, as air circulation must be ensured. Do not touch the hot parts without prior protective measures to avoid burns.

Non-observance of the above may result in accidents and fires!

Recommendation: Above 140 °C insulating the valves is strictly recommended.

Observe admissible temperatures, refer to «Use» on page 1 and «Technical data» on page 12

If an auxiliary switch is required, its switching point should be indicated on the plant schematic.

Every actuator must be driven by a dedicated controller (refer to «Connection diagrams», page 15).

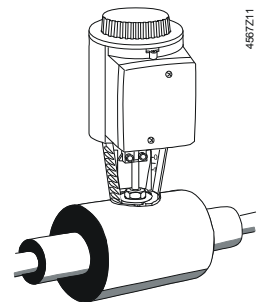

487211

Mounting instructions

Mounting Instruction 74 319 0324 0 for fitting the actuator to the valve are by packed in the actuator packaging. The instructions for accessories are enclosed with the accessories themselves.

| Accessories | Installation instructions | | Accessory | Mounting instructions | |
|---------------|---------------------------|---------------|-------------------------|-----------------------|---------------|
| ASC1.6 | G4563.3 | 4 319 5544 0 | ASZ6.5 | M4563.7 | 4 319 5564 0 |
| ASC9.3 | G4561.3 | 4 319 5545 0 | ASZ7.3.. | | 74 319 0247 0 |
| SKC.. | M3240 | 74 319 0324 0 | ACT control unit | M4568 | 74 319 0554 0 |
| SKC.. | | 74 319 0326 0 | QAF21.. | | 74 319 0399 0 |

Orientation

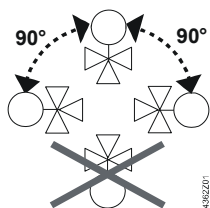

486201

When commissioning the system, check the wiring and functions, and set any auxiliary switches and potentiometers as necessary, or check the existing settings.

Cylinder with valve stem connector fully retracted
→ stroke = 0%

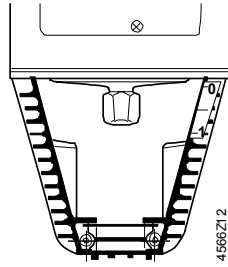

Cylinder with valve stem connector fully extended
→ stroke = 100 %

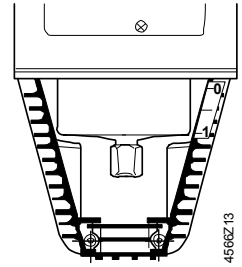

The manual adjuster must be rotated counterclockwise to the end stop. This causes the Siemens valves, types VVF.. and VXF.. to close (stroke = 0 %).

Automatic operation

For automatic operation, the crank (2) on the manual adjustment knob (1) must be engaged. If not engaged, turn the crank counter-clockwise until the display window (3) neither shows the scale (4) nor the crank engagement bar.

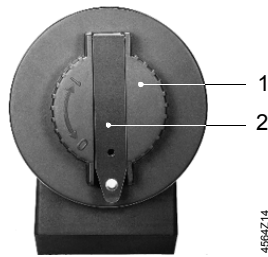

Engaged crank (2) on the manual adjustment knob (1)

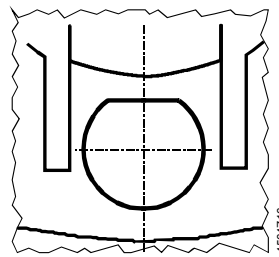

Display window with invisible scale dial and crank engagement bar

Manual operation

For manual operation, swing out the crank (2) so that the display window (3) becomes visible. By rotating the crank or the manual adjustment knob (1), the display window shows the engagement bar and/or the scale dial with stroke indication.

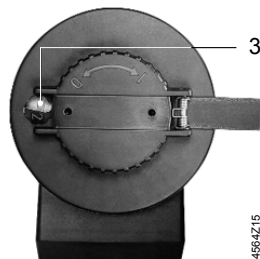

Swung-out crank, display window (3)

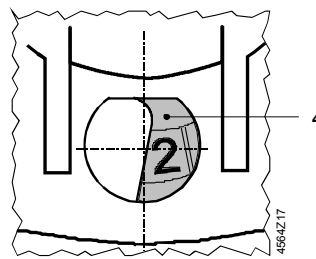

Display window with scale dial (4) and stroke indication

Maintenance notes

The SKC.. actuators are maintenance-free.



When servicing the actuator:

- Switch off pump of the hydronic loop
- Interrupt the power supply to the actuator
- Close the main shutoff valves in the system
- Release pressure in the pipes and allow them to cool down completely
- If necessary, disconnect electrical connections from the terminals
- The actuator must be correctly fitted to the valve before recommissioning.

Recommendation SKC6...: trigger stroke calibration.

Repair

«Replacement parts», see page 17.



A damaged housing or cover represents an injury risk

- **NEVER** uninstall an actuator from the valve
- **Uninstall the valve-actuator combination (actuating device) as a complete device**
- **Use only properly trained technicians to uninstall the unit**
- **Send the actuating device together with an error report to your local Siemens representative for analysis and disposal**
- **Properly mount the new actuating device (valve and actuator)**

Parts could fly ultimately resulting in injuries from uninstalling an actuator with a damaged valve housing due to the tensioned return spring.

Disposal



The device contains electrical and electronic components and must not be disposed of together with domestic waste. This applies in particular to the PCB.

Legislation may demand special handling of certain components, or it may be sensible from an ecological point of view.

Current local legislation must be observed.

Warranty

The technical data relating to specific applications are valid only in conjunction with the valves listed in this Data Sheet under «Equipment combinations», page 3.



The use of the actuators in conjunction with third-party valves invalidates all claims under Siemens Switzerland Ltd warranty.

Technical data

| | | SKC32.. | SKC82.. | SKC6.. | |
|----------------------------|---|---|--|--|-------|
| Power supply | Operating voltage | AC 230 V | AC 24 V | AC 24 V | |
| | Voltage tolerance | ± 15 % | ± 20 % | -20 % / +30 % | |
| | | SELV / PELV | | | |
| | Frequency | 50 or 60 Hz | | | |
| | Max. Power consumption at 50 Hz | SKC32.60: 19 VA / 16 W SKC32.61: 24 VA / 21 W | SKC82.60, ..60U 19 VA / 16 W SKC82.61, ..61U 24 VA / 21 W | SKC62.. 28 VA / 20 W SKC60 24 VA / 18 W | |
| External supply cable fuse | min. 0.5 A, slow max. 6 A, slow | min. 1.6 A, slow max. 10 A, slow | | | |
| Signal inputs | Control signal | 3-position | | DC 0...10 V, DC 4...20 mA, 0...1000 Ω | |
| | Terminal Y | Voltage Input impedance Current Input impedance Signal resolution Hysteresis | | DC 0...10 V 100 kΩ DC 4...20 mA 240 Ω < 1% 1 % | |
| | Terminal Z Override control | Resistor Z not connected Z connected directly to G Z connected directly to G0 Z connected to M via 0...1000 Ω | | 0...1000 Ω No function, priority terminal Y max. stroke 100 % min. stroke 0 % stroke proportional to R | |
| | Terminal U | voltage load impedance current load impedance | | DC 0...9,8 V ±2 % > 10 kΩ DC 4...19,6 mA ±2 % < 500 Ω | |
| Operating data | Positioning time at 50 Hz | opening | SKC32.6.. 120 s | SKC82.6.. 120 s | 120 s |
| | | Closing | SKC32.6.. 120 s | SKC82.6.. 120 s | 20 s |
| | Spring-return time (closing) | SKC32.61 18 s | SKC82.61 18 s | SKC60 - | |
| | | SKC32.60 - | SKC82.60 - | SKC62.. 20 s | |
| | Positioning force | 2800 N | | | |
| | Nominal stroke | 40 mm | | | |
| | Max. permissible medium temperature | -25...220 (350) °C < 0 °C: requires stem heater ASZ6.5 | | | |
| Electrical connections | Cable entry ..U | 4 x M20 (Ø 20,5 mm) with knockouts for standard ½" conduit connectors (Ø 21.5 mm) | | | |
| Norms and standards | CE-conformity | 2004/108/EC | | | |
| | EMC-directive | Immunity EN 61000-6-2 Industrial Emission EN 61000-6-3 Residential | | | |
| | Low voltage directive | 2006/95/EC | | | |
| | Electrical safety | EN 60730-1 | | | |
| | Product standards for automatic electric controls | EN 60730-2-14 | | | |
| | Protection standard EN 60730 | I | III | | |
| | Housing protection standard Upright to horizontal | IP54 to EN 60529 | | | |
| | Conform with UL standards | SKC82..U | UL 873 | | |

| | | SKC32.. | SKC82.. | SKC6.. |
|-----------------------------|---|---------------------------------------|---|--|
| | | SKC62U, SKC62UA | | UL873 |
| C-tick | | | N474 | N474 |
| Environmental compatibility | ISO 14001 (Environment) ISO 9001 (Quality) SN 36350 (Environmentally compatible products) RL 2002/95/EG (RoHS) | | | |
| Dimensions / Weight | Dimensions | refer to «Dimensions», page 16 | | |
| | Weight | SKC32.60 9.80 kg SKC32.61 10.00 kg | SKC82.60 9.90 kg SKC82.60U 10.15 kg SKC82.61 10.00 kg SKC82.61U 10.25 kg | SKC60/62 9.95 kg SKC62U/UA 10.20 kg |
| Materials | Actuator housing, bracket | Die-cast aluminum | | |
| | Housing box and manual adjuster | Plastic | | |

| Accessories | | SKC32.., SKC82.. | SKC6.. |
|-----------------------------------|---|---|---|
| ASC1.6 Auxiliary switch | Switching capacity | | AC 24 V, 10 mA...4 A resistive, 2 A inductive |
| ASC9.3 double auxiliary switch | Switching capacity per auxiliary switch | AC 250 V, 6 A resistive, 2.5 A inductive | |
| ASZ7.3 Potentiometer | Change in overall resistance of potentiometer at nominal stroke | ASZ7.3 0...1000 Ω ASZ7.31 0...135 Ω ASZ7.32 0...200 Ω | |
| | min. current in sliding contact | 0,05 mA | |
| | expected lifetime | 250'000 full lifts | |
| | max. current in sliding contact | 2,5 mA | |
| | expected lifetime | 100'000 full lifts | |
| ASZ6.5 stem heater | Operating voltage | AC 24 V ± 20 % | |
| | Power consumption | 30 VA | |

SKC62UA enhanced functions

| | | |
|------------------------|----------------------------------|---|
| Direction of operation | Direct-acting, reverse-acting | DC 0...10 V / DC 10...0 V DC 4...20 mA / DC 20...4 mA 0...1000 Ω / 1000...0 Ω |
| Stroke limit control | Range of lower limit | 0...45 % adjustable |
| | Range of upper limit | 100...55 % adjustable |
| Sequence control | Terminal Y | |
| | Starting point of sequence | 0...15 V adjustable |
| | Operating range of sequence | 3...15 V adjustable |
| Signal addition | Z connected to R of | |
| | Frost protection monitor QAF21.. | 0...1000 Ω, added to Y signal |
| | Frost protection monitor QAF61.. | DC 1.6 V, added to Y signal |

General ambient conditions

| | Operation EN 60721-3-3 | Transport EN 60721-3-2 | Storage EN 60721-3-1 |
|--------------------------|---------------------------|---------------------------|-------------------------|
| Environmental conditions | Class 3K5 | Class 2K3 | Class 1K3 |
| Temperature | -15...55 °C | -30...65 °C | -15...55 °C |
| Humidity | 5...95 % r.h. | < 95 % r.h. | 5...95 % r.h. |

Internal diagrams

SKC32.61
AC 230 V, 3-Position

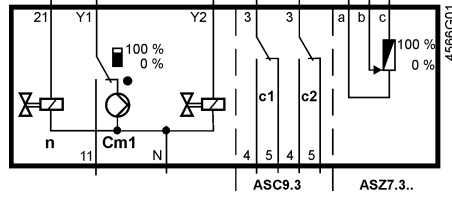

- Cm1** end switch
- n** solenoid valve for spring-return
- c1, c2** ASC9.3 double auxiliary switch
- a, b, c** ASZ7.. potentiometer
- Y1** Positioning signal «open»
- Y2** Positioning signal «close»
- 21** spring-return function
- N** neutral conductor

SKC32.60
AC 230 V, 3-Position

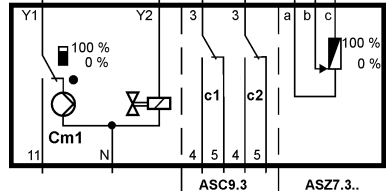

SKC82.61
AC 24 V, 3-Position

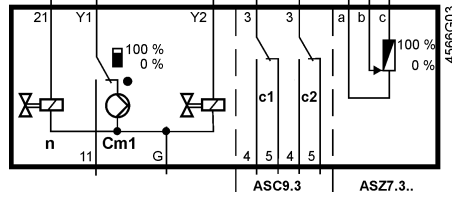

- Cm1** end switch
- n** solenoid valve for spring-return
- c1, c2** ASC9.3 double auxiliary switch
- a, b, c** ASZ7.. potentiometer
- Y1** Positioning signal «open»
- Y2** Positioning signal «close»
- 21** spring-return function
- G** System potential

SKC82.60
AC 24 V, 3-Position

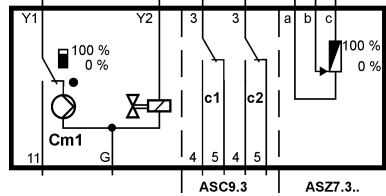

SKC60, SKC62
SKC60U, SKC62U
SKC62UA
AC 24 V, DC 0...10 V,
4...20 mA, 0...1000 Ω

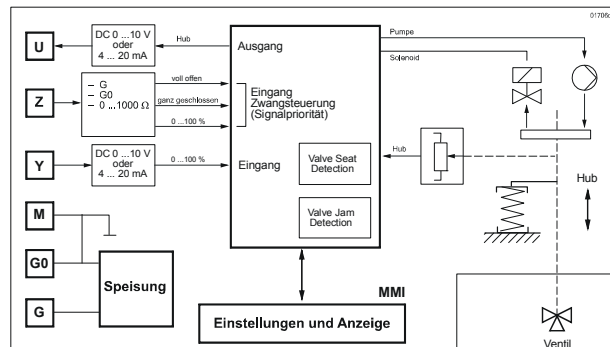

- U** position indication
- Z** override control
- Y** positioning signal
- M** measuring neutral
- G0** operating voltage AC 24 V: system neutral (SN)
- G** operating voltage AC 24 V: system potential (SP)

Connection terminals

SKC6..

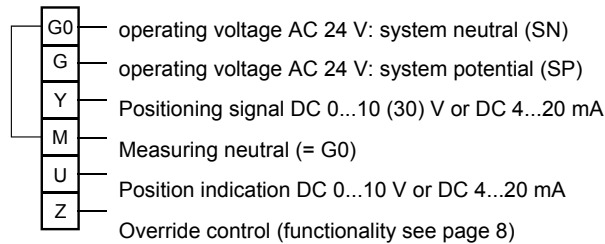

Auxiliary switch
ASC1.6

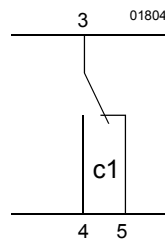

Connection diagrams

SKC32..
AC 230 V
3-Position

SKC32.61
AC 230 V

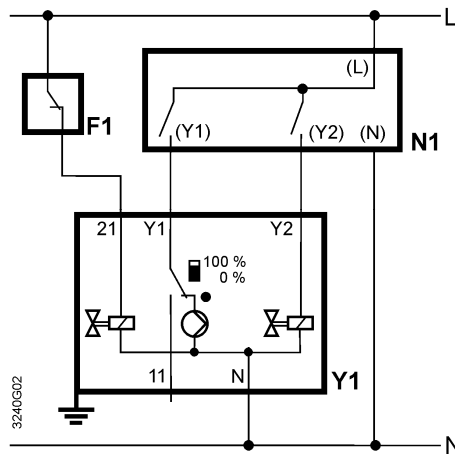

F1 temperature limiter
N1, N2 controller
Y1, Y2 actuators
L Phase
N neutral

SKC32.60
AC 230 V

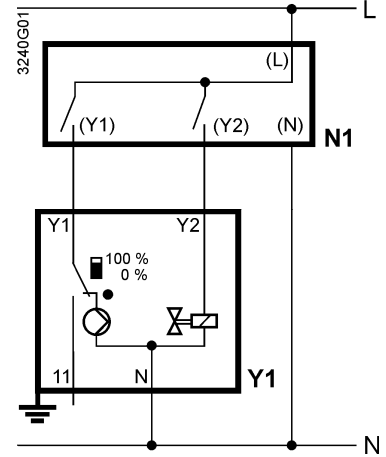

Y1 Positioning signal «open»
Y2 Positioning signal «close»
21 Spring-return function

SKC82..
AC 24 V
3-Position

SKC82.61, SKC82.61U
AC 24 V

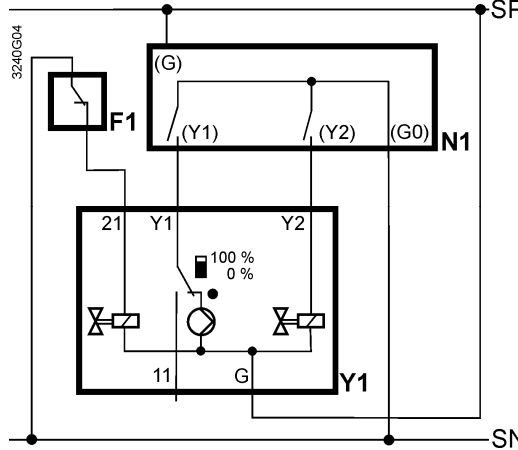

F1 temperature limiter
N1, N2 controller
Y1, Y2 actuators
SP Systempotential AC 24 V
SN System neutral

SKC82.60, SKC82.60U
AC 24 V

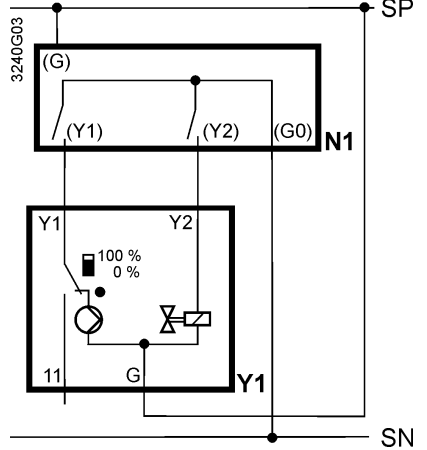

Y1 Positioning signal «open»
Y2 Positioning signal «close»
21 Spring-return function

SKC6..
AC 24 V
DC 0...10 V, 4...20 mA,
0...1000 Ω

SKC60
AC 230 V
AC 24 V

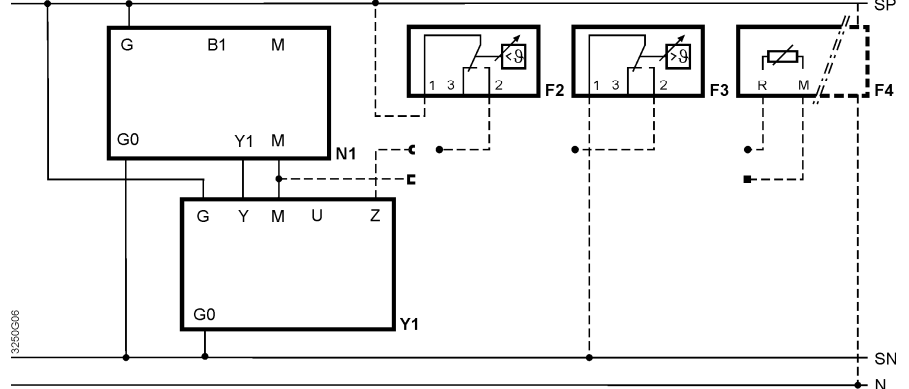

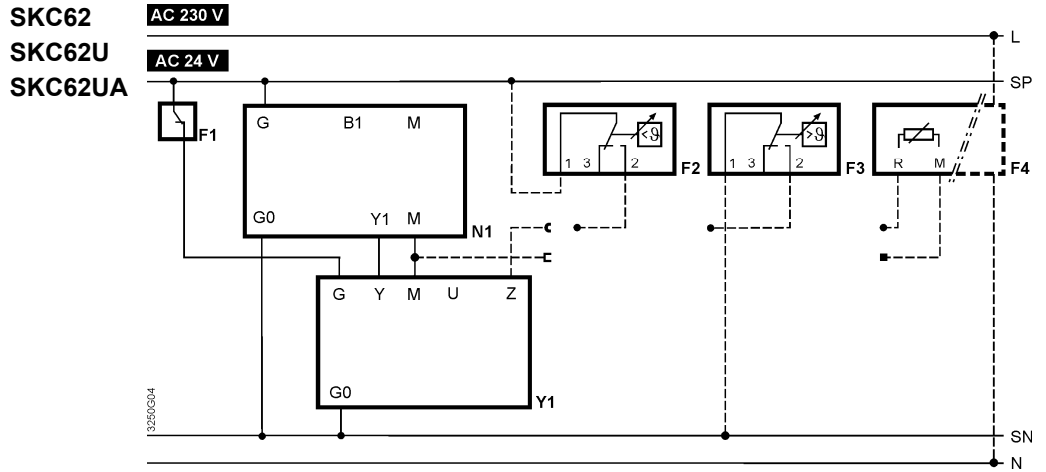

- Y1** actuator
N1 controller
F1 temperature limiter
F2 frost protection thermostat
 terminals: 1 – 2 frost hazard / sensor is interrupted (thermostat closes with frost)
 1 – 3 normal operation
F3 temperature detector
F4 Frost protection monitor with 0...1000 Ω signal output, e.g. QAF21.. or QAF61.. (only SKB62UA) *
G (SP) System potential AC 24 V
G0 (SN) System neutral
 * Only with sequence control and the appropriate selector switch settings (see page 5ff)



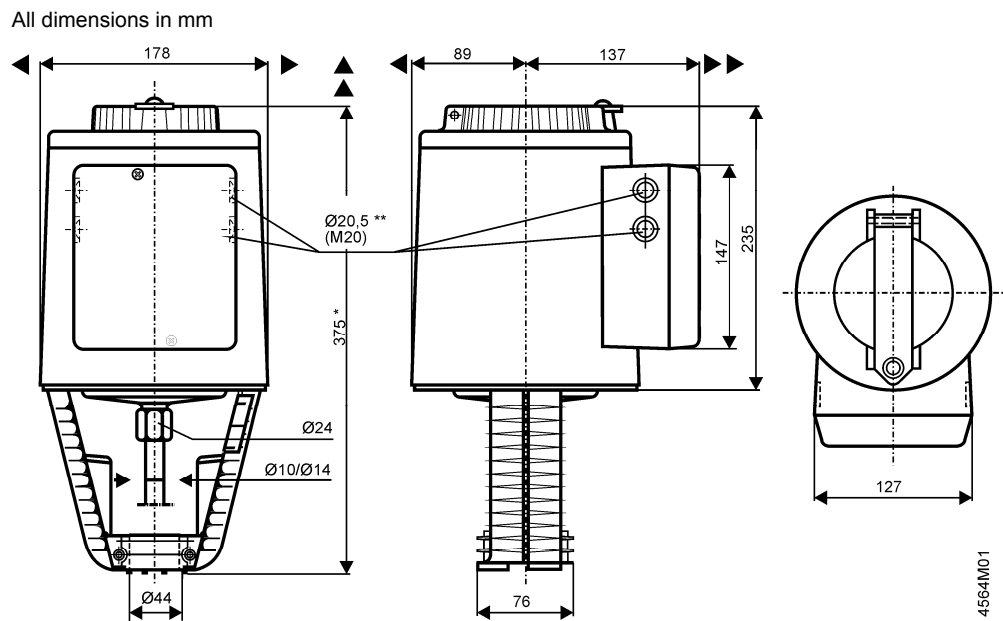

Dimensions

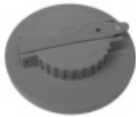

- ** SKC..U:** with knockouts for standard ½" conduit connectors (Ø 21.5 mm)
 ► = > 100 mm, minimum clearance from ceiling or wall for mounting,
 ►► = > 200 mm, connection, operation, maintenance etc.

Replacement parts

Order numbers for replacement parts

| Actuator type | Cover | Hand control ¹⁾ | Clamp | Stem connection | Control unit |
|------------------|---|---|---|---|---|
| |  |  |  |  |  |
| SKC32.60 | 410455828 | 426855108 | 410355768 | 417856498 | |
| SKC32.61 | 410455828 | 426855108 | 410355768 | 417856498 | |
| SKC82.60 | 410455828 | 426855108 | 410355768 | 417856498 | |
| SKC82.60U | 410455828 | 426855108 | 410356058 | 417856498 | |
| SKC82.61 | 410455828 | 426855108 | 410355768 | 417856498 | |
| SKC82.61U | 410455828 | 426855108 | 410356058 | 417856498 | |
| SKC62 | 410455828 | 426855108 | 410355768 | 417856498 | 466857488 |
| SKC62U | 410455828 | 426855108 | 410356058 | 417856498 | 466857488 |
| SKC60 | 410455828 | 426855108 | 410355768 | 417856498 | 466857598 |
| SKC62UA | 410455828 | 426855108 | 410356058 | 417856498 | 466857518 |

1) hand control, blue with mechanical parts

Revision numbers

| Type reference | Valid from rev. No. | Type reference | Valid from rev. No. |
|----------------|---------------------|----------------|---------------------|
| SKC32.60 | ..C | SKC82.61U | ..C |
| SKC32.61 | ..C | SKC62 | ..F |
| SKC82.60 | ..C | SKC62U | ..F |
| SKC82.60U | ..C | SKC60 | ..F |
| SKC82.61 | ..C | SKC62UA | ..F |

