



ACVATIX™

Electromotoric actuator

SUA21/1

For zone valves and Combi valves

- AC 230 V operating voltage, 2-position control signal
- Positioning force 150 N
- Direct mounting with M30 x 1.5 union nut (no tools required)
- 3-wire connection with integral 1.5 m connecting cable
- LED indicates actuator motion
- Parallel connection of multiple actuators are possible

Use

- For Siemens Combi valves VPP46.. and VPI46.. (DN 10/15)
- For Siemens zone valves V..I46..
- Primarily in heating, ventilation and air conditioning systems for water-based control of hot water and cold water.
- Heating and cooling zones
- Control valves for fan coil units
- Zone valve for floor heating via heating distributors (manifolds)
- Chilled ceiling units
- On/off control for domestic hot water boilers
- Shut off valve for wall mounted boiler applications

Type summary

Type	Stock No.	Operating voltage	Positioning time		Control signal ¹⁾	Cable length
			open	close		
SUA21/1	S55176-A102	AC 230 V	10 s at 50 Hz		2-position, SPST	1.5 m

¹⁾ SPST = single pole, single throw

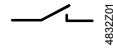

Ordering

When ordering please specify the quantity, product name and type code.

Example:

Type	Stock No.	Description	Quantity
SUA21/1	S55176-A102	Electromotoric actuator	2

Delivery

The valves and actuators are supplied in separate packages. The position of the actuator stem is retracted when supplied for better valve assembly.

Equipment combinations

Zone valves

Type	Description	k_{vs} [m ³ /h]	PN class	Δp_{max} [kPa]	DN	Data sheet
VVI46.15..	2-port valve, internal thread Rp	2...5	PN 16	300	15	N4842
VVI46.20..	2-port valve, internal thread Rp			300	20	
VVI46.25..	2-port valve, internal thread Rp			250	25	
VXI46.15..	3-port valve, internal thread Rp			300	15	
VXI46.20..	3-port valve, internal thread Rp			300	20	
VXI46.25..	3-port valve, internal thread Rp			250	25	

k_{vs} Nominal flow rate of cold water (5...30 °C) through the fully open valve (H_{100}) by a differential pressure of 100 kPa (1 bar)

Δp_{max} Maximum permissible differential pressure across the valve's control path, valid for the entire actuating range of the motorized valve

Combi valves

Type	Valve type	\dot{V} [l/h]	PN class	Data sheet
VPP46.., VPI46.. (DN 10/15)	Combi valves	30...575	PN 25	N4855

Room thermostats

Type code	Room thermostat compatible to SUA21/1
RAB..	RAB10; RAB10.1; RAB20; RAB20.1; RAB30; RAB30.1; RAB40.1
RCC..	RCC10; RCC20; RCC30
RDF..	RDF10; RDF10.1; RDF20; RDF30; RDF110..; RDF210..; RDF300..; RDF400..

Technical design

The actuator opens the valve electrically. It incorporates an electric motor and gear mechanism. The maximum stroke is limited mechanically (valve seat). No power consumption in end position. The actuator is connected with a 1.5 m cable, which is an integral part of it. The actuator can open or close the valve via controller (thermostat) output signal.

2-position SPST control signal

The actuator requires an on/off controller.

- | | | |
|--------------------|---------------|--------------|
| • Voltage at Y: | Stem retracts | Valve opens |
| • No voltage at Y: | Stem extends | Valve closes |

⚠ Caution

Do not operate the SUA21/1 actuators in a 3-position control mode!
LED operating mode display, e.g. SUA21/1:

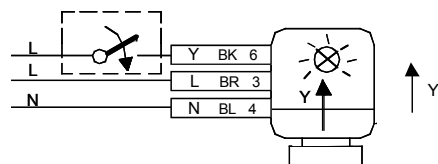

Voltage on Y: LED is lit
No voltage on Y: LED is off at end position

The LED is lit when the actuator stem retracts and the valve opens.

Engineering notes

The admissible temperatures (see «Technical data») must be observed.

Electrical installation

- Operate the actuator only with alternating current (see «Technical data»).
- Installation must be carried out in compliance with local installation regulations.
- The cable should not be twisted.
- Magnets can damage the actuator.
- A means of isolation from the power supply must be provided, for example: connecting a circuit breaker or switch fuse upstream of the control unit.

⚠ Caution

- **Phase cut and pulse-duration-modulated (PDM) signals are not suitable.**
- **Regulations and requirements to ensure the safety of people and property must be observed at all times!**

Mounting notes

The mounting instructions 74 319 0718 0 are enclosed in the packaging.

Valve and actuator are easy to assemble on site before commissioning:

- Remove protective cover from the valve body.
- Put the actuator in position and tighten the union nut manually.

⚠ Warning

Do not use pipe wrenches, spanners or similar tools.

Orientation

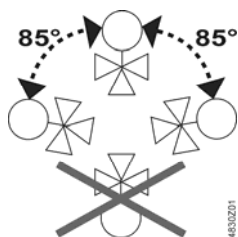

Commissioning notes

- Check wiring.
- Check the functions of the actuator.

Maintenance notes

Repair

SUA21/1 actuators require no maintenance.

Faulty actuators cannot be repaired and must be replaced by complete units. The actuator can be replaced without removing the valve.

 **Warning**

The operating voltage must be switched off during this process

Disposal

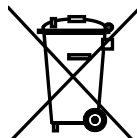

The device contains electrical and electronic components and must not be disposed of as domestic waste. This applies in particular to the PCB.

Legislation may demand special handling of certain components, or it may be sensible from an ecological point of view.

Current local legislation must be observed.

Warranty

The technical data given for these applications is valid only when the valves are used with the actuators described under «Equipment combinations».

The use of type SUA21/1 actuators with any third-party valves invalidates any warranty offered by Siemens Switzerland Ltd.

Technical data

		SUA21/1
Power supply	Operating voltage	AC 230 V
	Voltage tolerance	±15%
	Frequency	50/60 Hz
	Power consumption	6 VA at 50 Hz (when running only)
	Primary fuse	external
Signal inputs	Control signal	2-position (SPST) ¹⁾
	Parallel operation	permitted ²⁾
	Position with de-energized contact Y	see «Technical design»
Operating data	Positioning time (open/close)	10 s at 50 Hz 8.3 s at 60 Hz
	Positioning force	150 N
	Nominal stroke	2.5 mm
	Permissible temperature of medium in the connected valve	1...110 °C
	Connecting cable (integral)	3-core, 1.5 m 3 x 0.75 mm ² (18 AWG)
Mounting	Fixing on valve	plastic union nut M30 x 1.5
	Orientation	upright to 85° horizontal; do not suspend
Norms and standards	CE-conformity EMC-directive	2004/108/EC EN 60730-1:2000 +A16:2007
	Emission/Immunity	
	Low voltage directive	2006/95/EC
	Electrical safety	EN 60730-1:2000 + Amendments EN 60730-2-14:1997 + Amendments
	Product standards for automatic electric controls	EN 60730-2-14:[1997]
	Housing protection degree	IP40
	Protection class	II to EN 60730-1
	Environmental compatibility	ISO 9001 (Quality) RL 2002/95/EG (RoHS)
	Dimensions	Refer to «Dimensions»
	Weight	320 g
Materials	Cover, base	PBT
Housing colors	Cover, base	plastic / light gray, RAL 7035
	Union nut	Silver-grey, RAL 7001

¹⁾ Phase cut and pulse-duration-modulated (PDM) signals are not suitable, 3 position operation not permissible, SPST = Single Pole, Single Throw

²⁾ Consider controller's output power

General ambient conditions

	Operation EN 60721-3-3	Transport EN 60721-3-2	Storage EN 60721-3-1
Environmental conditions	Class 3K3	Class 2K3	Class 1K3
Temperature	1...50 °C	-25...70 °C	-5...50 °C
Humidity	5...85% r. h.	<95% r. h.	5...95% r. h.

Connecting cable

SUA21/1

SPST

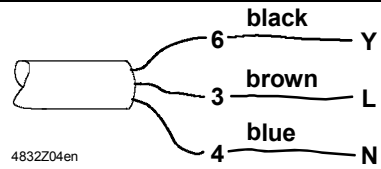

control signal OPEN (AC 230 V)

phase (AC 230 V)

neutral

Connection diagram

SUA21/1

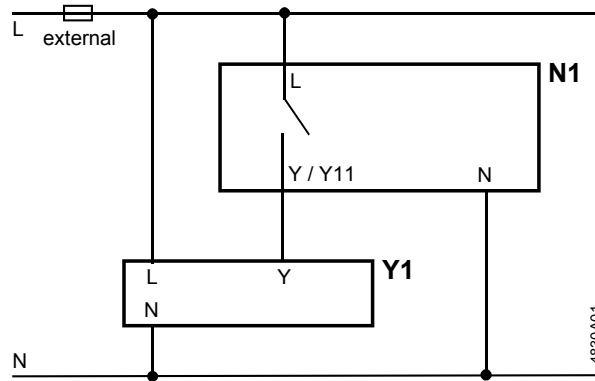

N1 = room thermostat
 Y1 = actuator SUA21/1
 Y/Y11 = control signal OPEN
 L = phase
 N = neutral

Dimensions

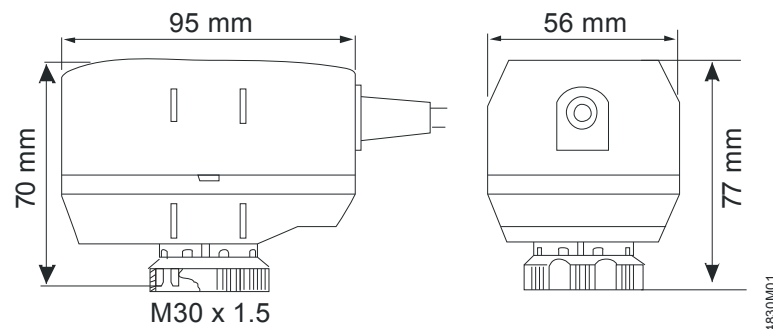

Revision numbers

Product number	Valid from rev. no.
SUA21/1	..B